

excite<sup>OSA</sup><sup>®</sup>

## Instructions for Use

**IMPORTANT SAFEGUARDS:  
READ ALL INSTRUCTIONS BEFORE USE**

---

# Contents

Important safeguards .....	3
What's in the box? .....	6
Intended use.....	8
eXcite <sup>OSA</sup> smartphone application .....	8
Using your eXcite <sup>OSA</sup> with a smartphone application .....	12
My eXcite <sup>OSA</sup> phone application .....	14
Frequency of usage .....	18
Charging the control unit.....	18
Storing & travelling with your eXcite <sup>OSA</sup> .....	19
Washing .....	19
Settings.....	20
Frequently asked questions.....	22
Trouble shooting .....	25
eXcite <sup>OSA</sup> system, operational requirements .....	26
eXcite <sup>OSA</sup> system, transport and storage requirements .....	26
Symbols used .....	28
Specifications .....	29
Declarations.....	32
Table A: Representative output with varying loads .....	34

---

# Important safeguards

## READ ALL INSTRUCTIONS BEFORE USE.

(for latest User Guide, please refer to <https://exciteosa.com>)

### WARNINGS

To avoid the risk of electrocution, burns, fire or physical injury:

- The device is only to be used **while awake**. It should not be used while sleeping.
- Only the supplied products should be used together. Do not use attachments other than those recommended by the manufacturer.
- Discontinue use if the product appears damaged in any way.
- Never attach the Mouthpiece directly to a charging source other than the control unit provided.
- This device should only be charged using the USB Cable provided.
- Do not operate in close proximity (e.g. 3.4 feet) to a shortwave or microwave unit as other Electromagnetic equipment may produce instability in the simulator output.
- Always keep the Control Unit away from water.
- Unplug the Control Unit immediately if it falls into water.
- Never use a damaged USB Cable to charge the Control Unit.
- This product contains no user serviceable parts. Refer to “Warranty” and “Trouble Shooting” if appliance no longer works as expected.
- The device is only to be used as specified in this document.

## READ ALL INSTRUCTIONS BEFORE USE.

### WARNINGS

To avoid the risk of physical injury:

- This device should not be used by persons:
  - children (under 18 years of age)
- eXcite<sup>OSA</sup> should be kept away from children and pets (choking hazard and electrical hazard).
- eXcite<sup>OSA</sup> to be used in a home or healthcare environment (or equivalent).
- The eXcite<sup>OSA</sup> durable control unit can be re-purposed for use by multiple successive patients.
- eXcite<sup>OSA</sup>'s disposable mouthpiece is for single patient use
- Do not use eXcite<sup>OSA</sup> when driving a vehicle or operating machinery and other equipment.
- When charging the device, keep away from all liquids.
- No modification of this device is allowed. Do not try to alter, trim or change any components of the device.
- The silicone on the mouthpiece must be intact before use. If there is any breach of the silicone (including electrodes) - **DO NOT USE THE MOUTHPIECE.**

**READ ALL INSTRUCTIONS BEFORE USE.**

**CONTRAINDICATIONS**

**Do not Use eXciteOSA if:**

- you are pregnant or may be pregnant
- you have a pacemaker or implanted electrodes
- you have dental braces or jewellery in your mouth.
- you are suffering from mouth ulceration or recent dental work.
- having or suspecting of having obstructive sleep apnoea with AHI greater than 15.

**Safety and effectiveness in the above conditions have not been established.**

**PRECAUTIONS**

**Consult your Doctor/Dentist if:**

- you have gum disease or have bleeding from your gums or other oral conditions.
- you experience pain, numbness or bleeding after using this product.
- you have any nose, throat conditions and previous oral surgery
- you have any medical conditions
  - Facial skeletal abnormalities
  - Obesity (BMI > 35)

**This device should not be used:**

- while asleep (device only to be used when **awake**)
- in contact with your head, neck, spine, chest, eyes, ears or any other parts of the body other than inside the mouth as instructed.

**Adverse Reactions:**

- accumulation of saliva
- tingling sensation on tongue

# What's in the box?

eXcite<sup>OSA</sup> package includes:

1

Mouthpiece (top view)

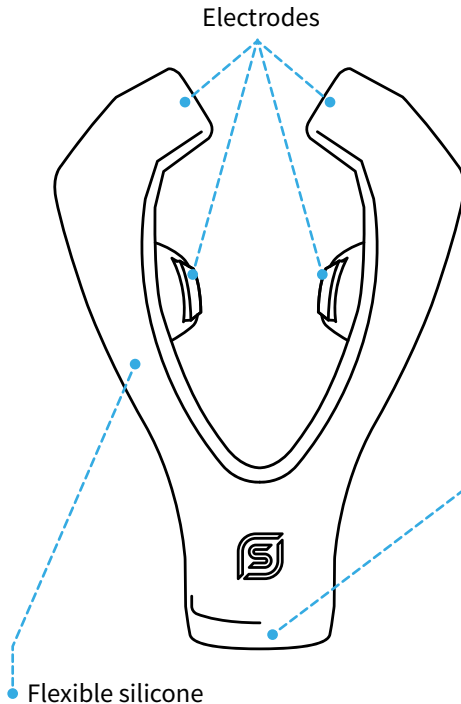

**If your device is received in packaging that is:**

- 1) damaged
- 2) unintentionally opened before use
- 3) packaging is exposed to environmental conditions outside of those specified please do not use the device and contact Signifier Medical Technologies.

Cleaning cap (please retain)



USB-C type connector

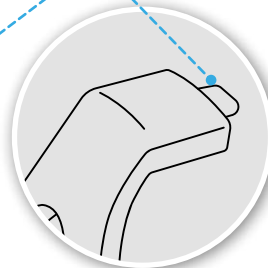

Fig.1

2

## Control Unit (With Bluetooth)

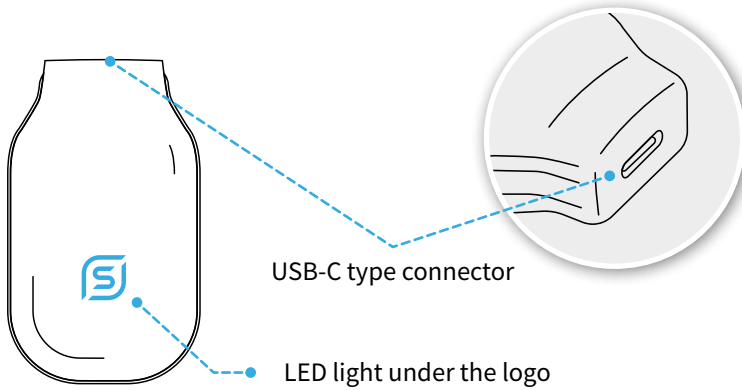

Fig.2

3

## USB Cable and adapter (15cm cable and included adapter)

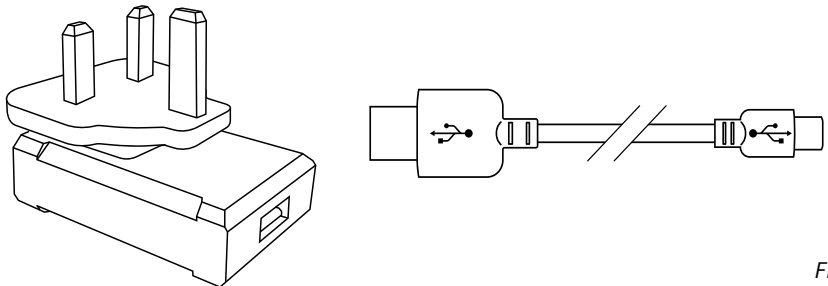

Fig.3

# Intended use

eXciteOSA is intended for the reduction of snoring and obstructive sleep apnoea by strengthening tongue muscles via electrical muscle stimulation.

**INDICATIONS FOR USE:** eXciteOSA is indicated for use to reduce snoring and mild sleep apnoea (AHI<15) for patients that are 18 years or older.

## eXciteOSA smartphone application

eXciteOSA device can be controlled by eXciteOSA Smartphone application. Smartphone application can be downloaded from App Store (Apple iOS) or Play Store (Google Android).

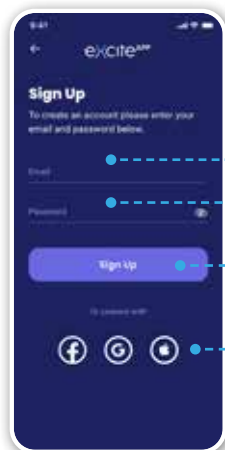

### LOG IN & SIGN UP

The log in & sign up section allows you to authenticate or create an account.

#### SIGN UP

- Enter the e-mail you want to register with
- Enter a secure password (minimum 6 characters)
- If you are already registered you can log in here
- You can sign up with one of these services  
*(this will require authentication on the appropriate external service)*



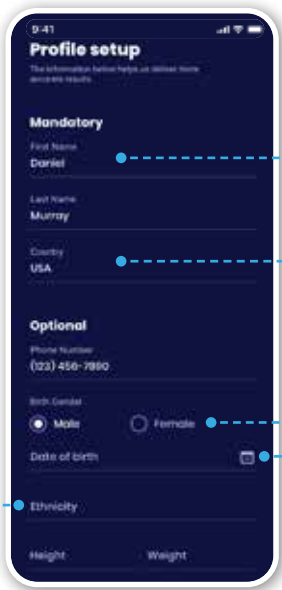

## PROFILE SET UP

- Enter your full name
- Enter your country of residence
- Select your gender

- Enter your ethnicity, height and weight\*
- Select your date of birth

*\* This data allows for better eXcite<sup>OSA</sup> therapy options. Your data is secure with us. You can check our privacy policy, on our website <https://exciteosa.com/privacy-policy>, for further details.*

Select whether you already have an eXcite<sup>OSA</sup> device or not.  
*If you choose yes, additional setup is required.*





## POLICY

There are a number of terms you have to agree to in order to use the eXcite<sup>OSA</sup> device with the mobile app.

First, make sure you read the Terms and Conditions page, and agree with them.

Next, please confirm that you do not use a pacemaker and that you are not pregnant. **It is very important that none of these apply to you as the eXcite<sup>OSA</sup> device can interfere with your pacemaker or with your baby's development.**

Also, you must be 18 years of age or older.

## LOG IN

Enter your registered e-mail and password  
If you forgot your password, tap here. You will receive an e-mail with further instructions.

You can log in with one of these services  
*(this will require authentication on the appropriate external service)*

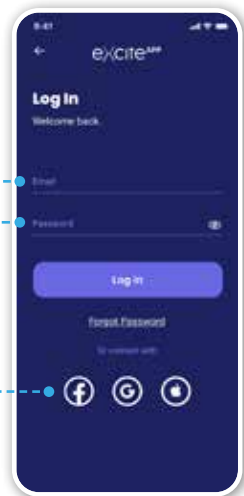

## THE DASHBOARD

The dashboard is the main screen of the app where all the features are available from.

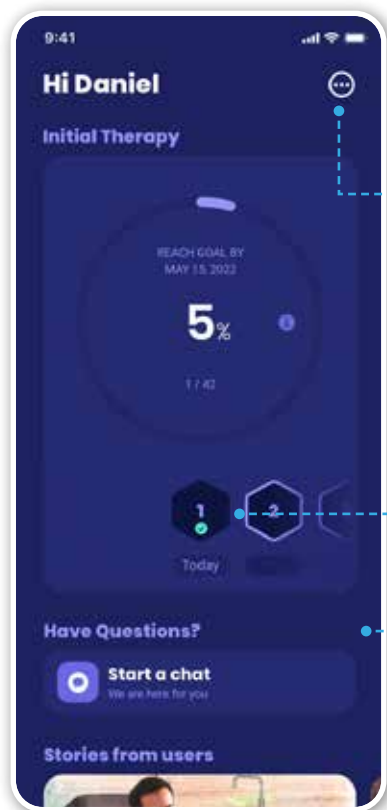

Settings

eXcite<sup>OSA</sup> therapy

Educational content

## Using your eXcite<sup>OSA</sup> with a smartphone application

Before starting your treatment be sure to: check the silicon on the Mouthpiece is not cracked or broken before use. If there is any evidence of damage to the silicon - **DO NOT USE THE MOUTHPIECE.**

Before use, wash the Mouthpiece with cold and running potable tap water as shown in Fig 4. Avoid water reaching the USB port. Dry with clean towel.

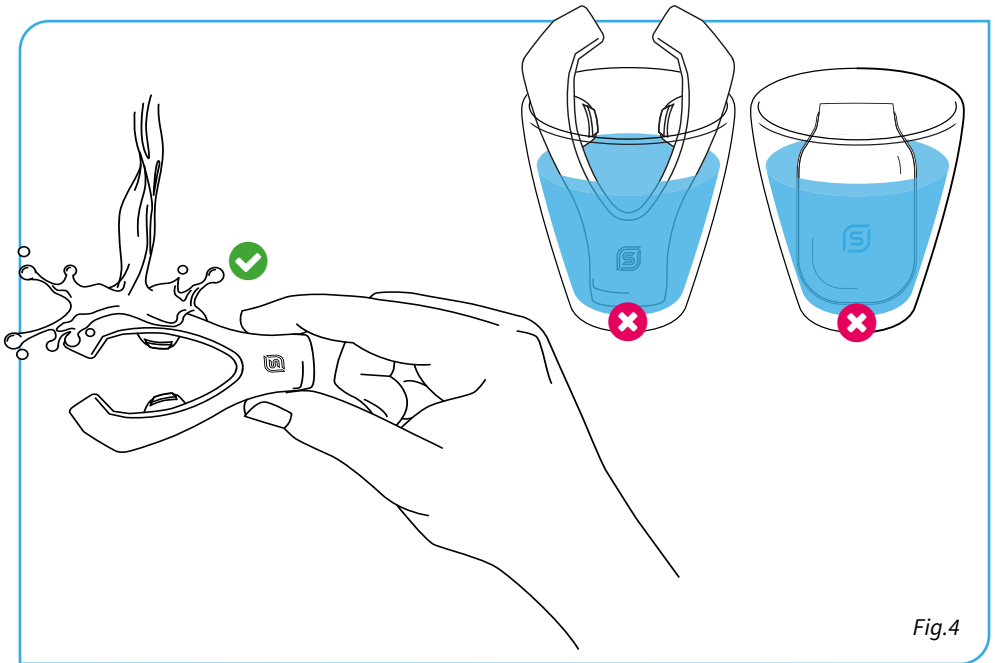
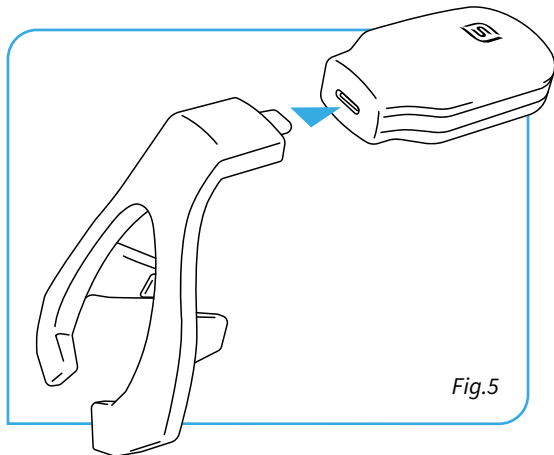

Fig.4



To start using eXciteOSA, connect the Mouthpiece with the Control Unit as shown on Fig 5.

Fig.5

Figure 6

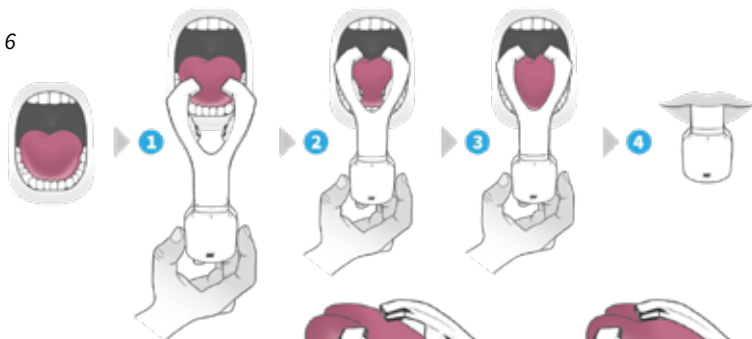

Insert the Mouthpiece into the mouth and allow it to sit around the tongue as shown in Fig 6. and gently close your mouth. Avoid grinding or clenching the Mouthpiece.

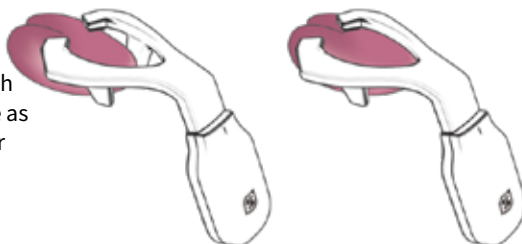

# My eXcite<sup>OSA</sup> phone application

My eXcite<sup>OSA</sup> is the place where you can start your eXciteOSA therapy or add your device.

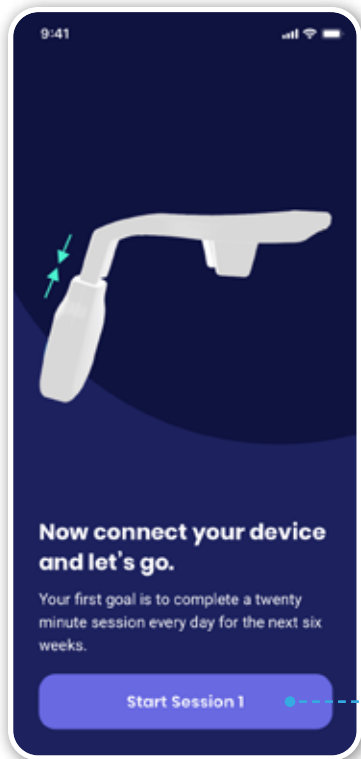

Add a eXcite<sup>OSA</sup> device  
*(make sure that the device is nearby)*

This screen will appear if you haven't already added a device.

**In order for the eXcite<sup>OSA</sup> device to work, you need to allow Bluetooth connection.**

For iOS 13 or above you need to manually allow Bluetooth permission.

Before starting your therapy be sure to: check your device for cracks or broken parts, connect the controller to the mouthpiece, insert the mouthpiece into the mouth.



## CONNECT

In order to start the therapy, you need to pair your phone with the control unit. Follow the instructions on the eXcite<sup>APP</sup> screen to connect and make sure the control unit is close to your phone.

You should see a blue flashing light to connect via Bluetooth to the phone.

### Controlling your therapy level

To change your therapy level, simply slide the level setting from the bottom of the bar on your screen.

It is important to set the device to the highest possible therapy level that still feels comfortable for you. This will ensure the best possible outcome.

If therapy becomes painful or uncomfortable, simply remove the mouthpiece or lower the therapy level.

Please follow the advice from the prescribing clinician on recommended starting therapy level.

Stops the therapy

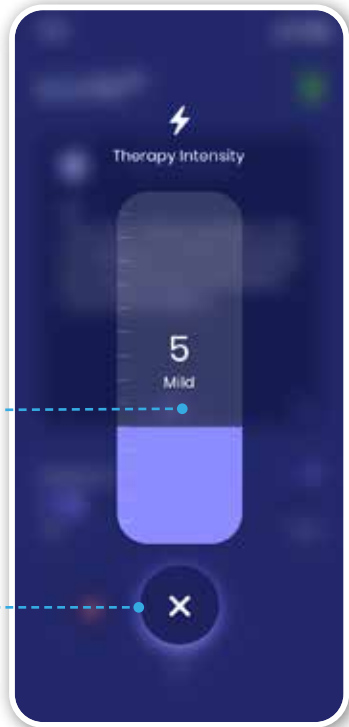

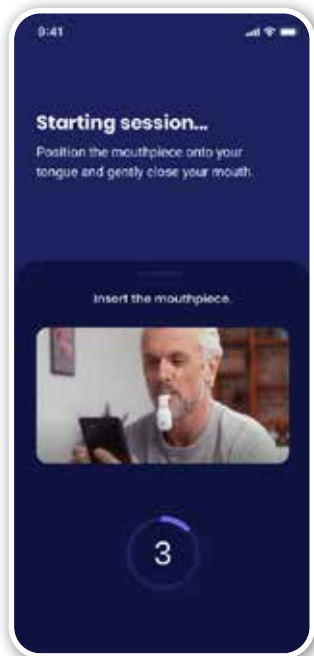

## COUNTDOWN

After pairing your eXcite<sup>OSA</sup> device with your mobile phone, your therapy will start with a countdown from 3 to 1 before initiating the actual therapy.

Therapy can be stopped at any time but due to safety reasons it can only be restarted after 30 minutes after the device has been stopped or the therapy has ended. Keep this in mind when stopping the therapy.

## STOP THERAPY

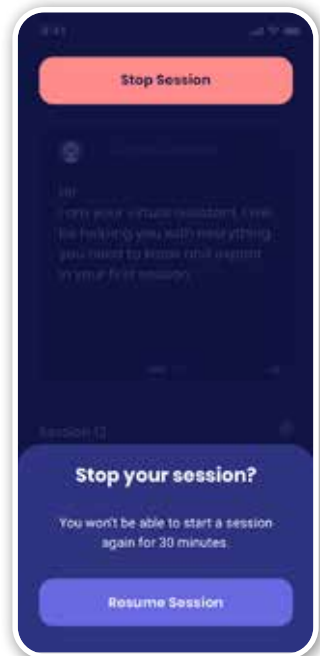



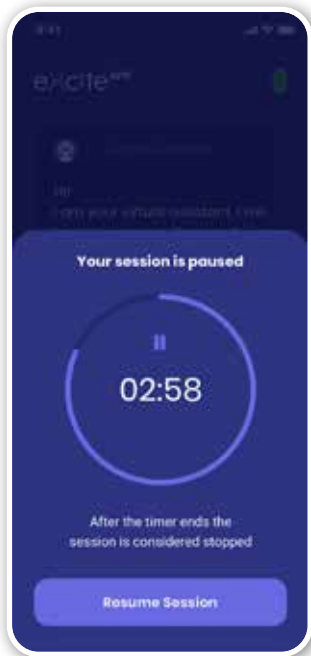

## PAUSE THERAPY

Therapy can be paused at any time. It can be paused only for 3 minutes. After the 3 minutes have passed the therapy is considered stopped and can only be restarted after 30 minutes.

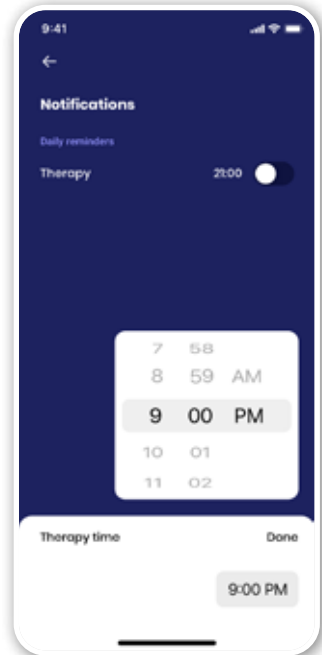

## SET A REMINDER

You can set a reminder at a specific time each day, so that you don't miss your therapy.

## END OF THERAPY SESSION

Therapy can be paused at any time for up to 3 minutes. After the 3 minutes have passed the therapy is considered stopped and can only be restarted after 30 minutes.

## Frequency of usage

It is recommended you use eXcite<sup>OSA</sup> once daily for a continuous 20 minutes. It can take up to 6 weeks of daily therapy before you will gain the desired improvement in your snoring. Once the desired results are achieved, it is recommended to have a once a week regular maintenance regime. eXcite<sup>OSA</sup> can be used long term. This is comparable to maintaining your physical fitness by undertaking regular exercise.

You are recommended to replace the Mouthpiece after **three months** of first use, which includes the maintenance period.

## Charging the control unit

Before using the device for the first time, you must charge the battery for at least 2 hours. The Control Unit LED will flash blue and amber if there is inadequate charge to run a full 20 minute therapy session. When Control Unit logo (Fig 8) blinks blue and amber, recharge the Control Unit. To charge the Control Unit, use the USB Cable provided and connect the Control Unit jack into a USB power adapter. During charging, the eXcite<sup>OSA</sup> logo will blink. When fully charged, the eXcite<sup>OSA</sup> logo will become continuous blue.

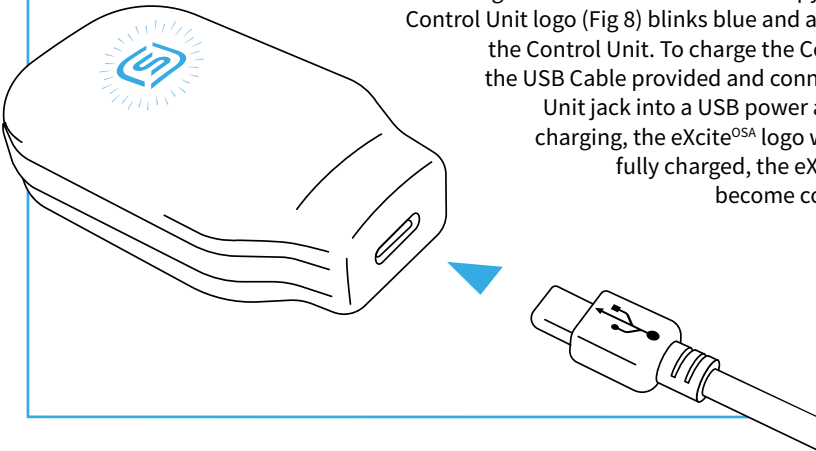

Fig.8

---

## Storing & travelling with your eXcite<sup>OSA</sup>

### **MOUTHPIECE**

Once the Mouthpiece has been washed in potable tap water and dried, it can be stored in its storage stand. The Mouthpiece is packaged in a removal stand which can be used for storage or regular stand for the Mouthpiece.

### **CONTROL UNIT**

The Control Unit must be kept dry throughout its use and storage. After use, store in a dry environment or the storage box. If you plan to travel with your eXcite<sup>OSA</sup>, place each unit in its original packaging to protect during transportation.

---

## Washing

### **MOUTHPIECE**

The Mouthpiece should be washed before and after each use. Use potable, running tap water to wash the Mouthpiece. Dry with a clean towel and store in a dry place. **DO NOT** wash with alcohol based cleaning solutions.

### **CONTROL UNIT**

Wipe the Control Unit surface with a damp cloth or antiseptic wipe once a week. **DO NOT** immerse the Control Unit in water or cleaning solutions. Always store the Control Unit in a dry place.

# Settings

Manage all of your settings from a single place.

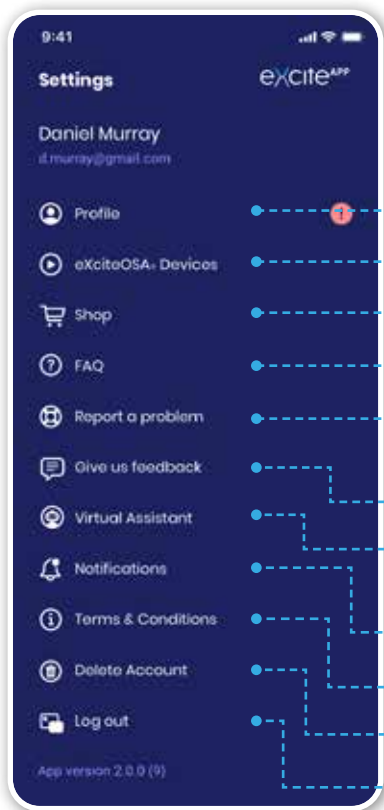

See and edit your profile

A list of your devices

Purchase device and mouthpieces here

A list of frequently asked questions

Had a problem with the app or device?  
You can report it here.

Give us feedback here

Enable Virtual Assistant for assistance  
during sessions

Manage your notifications settings

Terms & Conditions can be found here

Delete your account here

Log out of your account

## SEE/EDIT PROFILE

Change any of the data already provided and then tap 'Save', to save your changes.



## FAQ

Check the Frequented Asked Questions for further information.

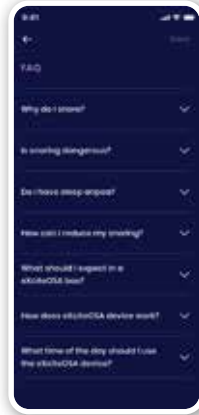

## REPORT A PROBLEM

Did anything go wrong with the app or the device? Describe the problem and let us know. We'll try to solve it and take the appropriate measures.



## NOTIFICATIONS

Change the time of your notifications. Enable or disable them, so that you can have a smoother experience.

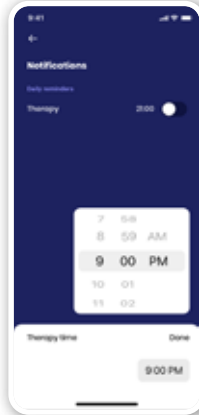

---

# Frequently asked questions

## **Why do I snore?**

Snoring is caused by vibration of the structures of the throat during sleep. When you sleep, the muscles of the throat relax and partially collapse. The narrowest parts of the throat can then create turbulence of the air flowing through your throat which makes the snoring sound

You're more likely to snore if you:

- are overweight
- drink too much alcohol
- smoke
- sleep on your back

## **Is snoring dangerous?**

It has been shown that Snoring affects sleep quality of the snorer and partner. It is important to note that snoring may just be the tip of the iceberg. Although snoring per say does not damage your health, Snoring can be a clue to a more serious condition called obstructive sleep apnoea (intermittent complete blockage of breathing during sleep).

## **Do I have sleep apnoea?**

Sleep apnoea is a serious health condition associated with health problems like high blood pressure and increased risks of heart attack, stroke, or death. It is often associated with day time sleepiness and your partner may notice you breath hold or stop breathing in the night.

If you have these symptoms or are concerned you may have the condition, please refer to your doctor.

### **How does eXcite<sup>OSA</sup> device work?**

The eXcite<sup>OSA</sup> device will deliver small electric currents through the Mouthpiece to your tongue, this will stimulate the tongue muscle and improve its tone. The improved tone of the tongue muscle will help in keeping the breathing passage open during your sleep and reduce the vibration of the throat region.

### **How soon do I see the result with eXcite<sup>OSA</sup>?**

You should notice an improvement in your snoring within 4 weeks. This is dependent upon adherence to the recommended therapy programme of one 20 minute session daily. Although you may see improvement within 4 weeks, we recommend you finish the 6 week therapy period to ensure you gain the optimal improvement possible.

### **At what level should I start and what is the optimum level for my treatment?**

The intensity always starts at level 1; it is recommended that you increase the intensity to a level that is comfortable for you for each therapy session. The therapy changes frequencies at 5 minute intervals. At these intervals the stimulation will automatically drop in intensity for comfort. If you feel any discomfort or lack of stimulation, then the intensity can be reduced or increased accordingly. Over the duration of the recommended therapy programme you will notice that your tolerance levels will increase, and you can go up in intensity comfortably. It is important to avoid increasing the intensity to beyond comfortable level, as higher intensity will not lead to additional improvement.

**What should I expect during and after my treatment?**

During the therapy you should experience a tingling sensation on the tongue and tongue muscle contractions. As the intensity is increased the muscle contraction will get stronger. Please remember to set the intensity at a level that is comfortable for you. Increasing the intensity beyond comfortable level will not improve the outcome of the therapy session. It may become an uncomfortable sensation.

**What time of the day should I use the eXcite<sup>OSA</sup> device?**

The eXcite<sup>OSA</sup> can be used anytime during the day, but it is recommended to be used before you go to sleep at night.



---

# Trouble shooting

The Control Unit powers up but the Mouthpiece does not work:

- Check the Control Unit has adequate power to run a 20 minutes therapy session
- Check there is no fluid ingress within the USB connector
- Check there is no damage to the mini USB connector
- Check there is no damage to the Mouthpiece
- If the above steps have been implemented, then contact the eXcite<sup>OSA's</sup> Help/Support team

## eXcite<sup>OSA</sup> system, operational requirements

Temperature +41°F to +104°F (+5°C to +40°C)

Humidity 15% to 90%

Atmospheric Pressure 10.15 psi to 15.37 psi (70 kPa to 106 kPa)

Operational life is 3 years.

## eXcite<sup>OSA</sup> system, transport and storage requirements

Temperature -13°F to +158°F (-25°C to +70°C)

Humidity up to 90%

Atmospheric Pressure 10.15 psi to 15.37 psi (70 kPa to 106 kPa)

When the device is exposed to extreme temperatures, please wait at least 60 minutes before attempting to use the device.

## **DISPOSAL**

Please return the products to your supplier for disposal. The Control Unit contains a rechargeable battery and should not be disposed in general waste.

## **FAULTS & REPAIRS**

eXcite<sup>OSA</sup> should be used in accordance with this User Guide above and with the approved accessories and contains no user serviceable parts. Do not try to repair, alter or change the components of the three individual units of the eXcite<sup>OSA</sup>, as this will invalidate your warranty. If the Mouthpiece or Control Unit is not functional due to wear and tear, it will not be covered by the warranty. The Mouthpiece is recommended to be replaced after 3 months of first use.

## **WARRANTY**

Signifier Medical Technologies Ltd. provides a warranty to the original purchaser confirming the product will be free from defects in the material, components and workmanship for a period of 3 months for the Mouthpiece and 1 year (Control Unit only) from the date of purchase. For valid warranty claims, the user may return after authorisation, the eXcite<sup>OSA</sup> directly to the local eXcite<sup>OSA</sup> contact or Signifier Medical Technologies Ltd. eXcite<sup>OSA</sup> warranty does not include any misuse or abuse such as dropping or immersing the Control Unit in water or other liquid substance or tampering with the unit or normal wear and tear. Any evidence of tampering will void the warranty. This warranty does not apply to “wear and tear” that would occur with usage.

## **CUSTOMER SERVICE**

Please contact your local Signifier Medical Technologies contact for any warranty returns. Your invoice of purchase should state the name and the contact details of your local Signifier Medical Technologies contact. For assistance in setting up, using or maintaining the unit, or to report unexpected operation or events please contact Signifier Medical Technologies customer service.

If you have an absence of clinical benefit following completion of 42 therapy sessions within an 8-week period, please contact your doctor or Signifier Medical Technologies.

# Symbols used



Refer to instructions manual



Storage Temperature Limits

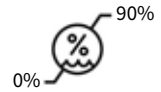

Humidity Limits



Catalog number



Serial number



Keep dry



Country & date of manufacture



Manufacturer



Type BF applied part



WEE directive



USB C



Federal Communications Commission



Medical Device

# Specifications

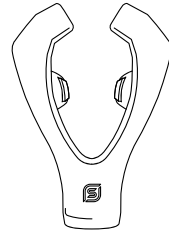

	Control Unit	Mouthpiece
Colour	White and Blue	White and Grey
Packaging	eXcite <sup>OSA</sup> is packed in a protective box package	
Power source	Rechargeable 100mAh LiPo cell	N/A
Max output voltage	32.4 V Output varies with impedance (see Table A on page ??)	
Max output current	70mA Output varies with impedance (see Table A on page ??)	
Output signal	100us/phase (Bi-Phasic output) Up to 20 Hz	
Operating temperature	From +41°F to +104°F (+5°C to +40°C)	
Storage temperature	-13°F to +158°F (-25°C to +70°C)	
Atmospheric Pressure Range	10.15 psi to 15.37 psi (70 kPa to 106 kPa)	
Humidity	Relative Humidity 20% to 85%	Relative Humidity up to 100%
Degree of Protection	Control Unit ( IP44) (IP 44 - Protection protected against objects > 1 ml and splashing water, IP42 - Protection protected against objects > 1 ml and dripping water) IP 64 - Mouthpiece (Protection against dust and splashing water) IP67 - Mouthpiece (Protection against dust and temporary immersion in water)	
Mode of operation	ON/OFF	

Radio Frequency Information	Control Unit
Frequency Band Of Reception	2.4 GHz to 2.48 GHz
The Bandwidth of The Receiving Section in Those Bands	2 MHz
Effective Radiated Power	up to 3.5 dBm

## IEC 60601-1-2:2014 (EDITION 4) / EN 60601-1-2:2015 (Home healthcare environment)

Standard	Category														
CISPR 11 / EN 55011	Emissions	Radiated Emissions (30 - 1000 MHz)	Class B												
CISPR 11 / EN 55011	Emissions	Conducted Emissions	N/A												
IEC/EN 61000-3-2	Emissions	Harmonic Current Emissions	N/A												
IEC/EN 61000-3-3	Emissions	Voltage Fluctuations and Flicker	N/A												
RTCA/DO160G	Emissions	Radiated Emissions (100 MHz - 6 GHz)	Section 21 Category M												
ANSI C63.4, FCC CRF 15.209 / ICES-003	Emissions	Radiated Emissions (30 MHz - 12.5 GHz)	Class B												
IEC/EN 61000-4-2	Immunity	Electrostatic Discharge Immunity	Air: 2,4,8,15kV. Contact: 8kV												
IEC/EN 61000-4-3	Immunity	Radiated RF Immunity	10 V/m: 80 MHz to 2.7 GHz. 3 V/m: 2.7 GHz to 6 GHz												
IEC/EN 61000-4-3 / IEC/EN 61000-4-39	Immunity	Immunity to Proximity fields from RF wireless communications equipment	<table border="0"> <tr> <td>385 MHz</td> <td>27 V/m</td> </tr> <tr> <td>450 MHz</td> <td>28 V/m</td> </tr> <tr> <td>710, 745, 780 MHz</td> <td>9 V/m</td> </tr> <tr> <td>810, 870, 930 MHz</td> <td>28 V/m</td> </tr> <tr> <td>1720, 1845, 1970, 2450 MHz</td> <td>28 V/m</td> </tr> <tr> <td>5240, 5500, 5785 MHz</td> <td>9 V/m</td> </tr> </table>	385 MHz	27 V/m	450 MHz	28 V/m	710, 745, 780 MHz	9 V/m	810, 870, 930 MHz	28 V/m	1720, 1845, 1970, 2450 MHz	28 V/m	5240, 5500, 5785 MHz	9 V/m
385 MHz	27 V/m														
450 MHz	28 V/m														
710, 745, 780 MHz	9 V/m														
810, 870, 930 MHz	28 V/m														
1720, 1845, 1970, 2450 MHz	28 V/m														
5240, 5500, 5785 MHz	9 V/m														
IEC/EN 61000-4-4	Immunity	Electrical Fast Transients Immunity	N/A												
IEC/EN 61000-4-5	Immunity	Voltage Surge Immunity	N/A												
IEC/EN 61000-4-6	Immunity	Conducted RF Immunity	N/A												
IEC/EN 61000-4-8	Immunity	Power Frequency Magnetic Field Immunity	N/A												
IEC/EN 61000-4-11	Immunity	Voltage Dips and Short Interruptions Immunity	<table border="0"> <tr> <td>100 % reduction for Half Cycle</td> </tr> <tr> <td>30 % reduction for 25/30 Cycles</td> </tr> <tr> <td>100 % reduction for 1 Cycle</td> </tr> <tr> <td>&gt;95 % reduction for 250/300 Cycles</td> </tr> </table>	100 % reduction for Half Cycle	30 % reduction for 25/30 Cycles	100 % reduction for 1 Cycle	>95 % reduction for 250/300 Cycles								
100 % reduction for Half Cycle															
30 % reduction for 25/30 Cycles															
100 % reduction for 1 Cycle															
>95 % reduction for 250/300 Cycles															

## **WARNING:**

- Use of this equipment adjacent to or stacked with other equipment should be avoided because it could result in improper operation. If such use is necessary, this equipment and the other equipment should be observed to verify that they are operating normally.
- Use of accessories, transducers and cables other than those specified or provided by the manufacturer of this equipment could result in increased electromagnetic emissions or decreased electromagnetic immunity of this equipment and result in improper operation.
- Portable RF communications equipment (including peripherals such as antenna cables and external antennas) should be used no closer than 30 cm (12 inches) to any part of the eXcite<sup>OSA</sup> System, including cables specified by the manufacturer. Otherwise, degradation of the performance of this equipment could result.

**If the eXcite<sup>OSA</sup> system is exposed to EM disturbance, there should not be any loss or degradation to performance. However the performance should be monitored for the accuracy of waveform.**

---

# Declarations

## **FOR USA**

FCC warning statement:

This device complies with Part 15 of the FCC Rules.

- Operation is subject to the following two conditions:
  1. This device may not cause harmful interference, and
  2. This device must accept any interference received, including interference that may cause undesired operation.
- This equipment complies with FCC radiation exposure limits set forth for an uncontrolled environment. End users must follow the specific operating instructions for satisfying RF exposure compliance. This transmitter must not be co-located or operating in conjunction with any other antenna or transmitter.
- Changes or modifications not expressly approved by the party responsible for compliance could void the user's authority to operate the equipment

## **FOR CANADA**

*"This device complies with Industry Canada's licence-exempt RSSs. Operation is subject to the following two conditions:*

- 1. This device may not cause interference; and*
- 2. This device must accept any interference, including interference that may cause undesired operation of the device."*

Please see Section 8.4 of RSS-Gen Issue 4 for further information.



**Signifier Medical Technologies Limited**

107 Leadenhall St, London, EC3A 4AF, United Kingdom

Email: info@signifiermedical.com

www.exciteosa.com

**Distributed in the USA by**

Signifier Medical Technologies LLC

109 Highland Avenue Needham MA 02492

+1844 MILDOSA (+1844 645 3672)

**EU Authorised Representative**



**Advena Ltd. Tower Business Centre, 2nd Fl.,  
Tower Street, Swatar, BKR 4013 Malta**



**EU Importer**

Advena Services Ltd

Tower Business Centre, Tower Street

Swatar, BKR 4013 Malta

**This product is Manufactured by Signifier Medical Technologies**

in compliance with Medical Device Standards and Quality Standards: ISO 13485:2016

## Table A: Representative output with varying loads

Mouthpiece load	900 Ohm		500 Ohm		338 Ohm	
Therapy level	Measured Voltage (V)	Calculated current (mA)	Measured Voltage (V)	Calculated current (mA)	Measured Voltage (V)	Calculated current (mA)
1	2.21	2.46	1.67	3.34	1.34	3.96
2	4.6	5.11	3.46	6.92	2.59	7.66
3	6.7	7.44	5.31	10.62	3.74	11.07
4	8.06	8.96	6.91	13.82	5.6	16.57
5	10.9	12.11	9.1	18.2	6.6	19.53
6	12.6	14	10.7	21.4	7.8	23.08
7	14.7	16.33	12.3	24.6	9.1	26.92
8	17.3	19.22	14.1	28.2	10.4	30.77
9	19.5	21.67	17.9	35.8	11.4	33.73
10	21.4	23.78	20.2	40.4	12.5	36.98
11	23.4	26	21.8	43.6	13.8	40.83
12	25.3	28.11	23.7	47.4	15.2	44.97
13	27.2	30.22	25	50	16.5	48.82
14	28.8	32	26.6	53.2	17.3	51.18
15	29.8	33.11	28.5	57	19.8	58.58



**Signifier**

MEDICAL TECHNOLOGIES



1282

User Guide English: 045300003 Dated May 2024